

Recessed LED panel

LED Panel with opal homogenous light emitting surface. Easy to adjust tuneable lumen output and colour temperature switch located on the luminaire. Gentle, soft and glare-free lighting with UGR <19 for schools and offices with opal diffuser made of TpB rated PET for fully homogenous illumination and aluminium frame. Total luminous flux: 4400 lm, Luminaire input power: 36 W, Luminaire efficacy: 122 lm/W, correlated colour temperature (CCT) adjustable via switch for 3000K, 3500K or 4000K. Lifetime: 50.000hrs @L80, Colour Rendering: CRI > 80, Chromaticity tolerance (initial MacAdam): 4. Provided with detachable quick connector for easy installation and tool-free loop-in loop-out wiring and safety wire, Flicker free, Suitable for lay-in installation. Available accessories: Plug&Play Emergency kit for 3 hour emergency conversion (Self or Manualtest), surface and recessed mounting kit. Lumen package adjustable on site by 4 steps FLEX@4000K: (FLEX1 - 4400 lm (36W), FLEX2 - 4000 lm (33W), FLEX3 - 3750 lm (30W), FLEX4 - 3000 lm (24W)). Detailed power setting information available on www.THORNeco.com. Dimensions: 596 x 596 x 35 mm, weight: 1.34 kg.

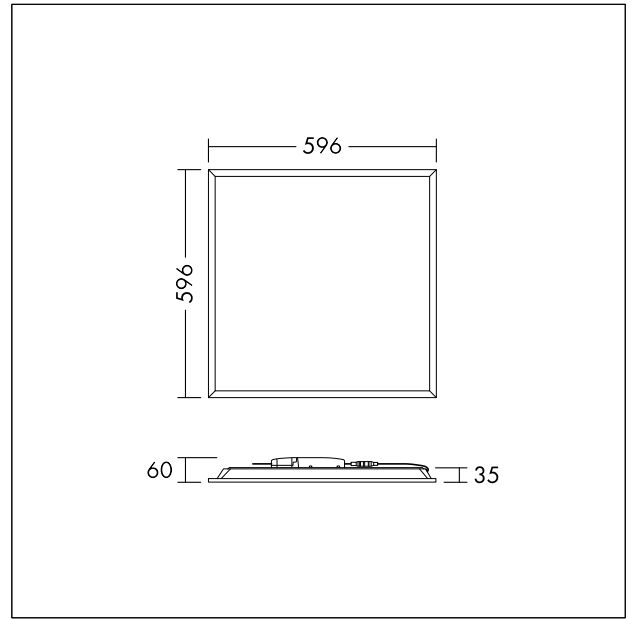

TE_ANNA_F_600_persp.jpg



TE_ANNAVF2_M_Q596.wmf

Light Distribution

STD - standard

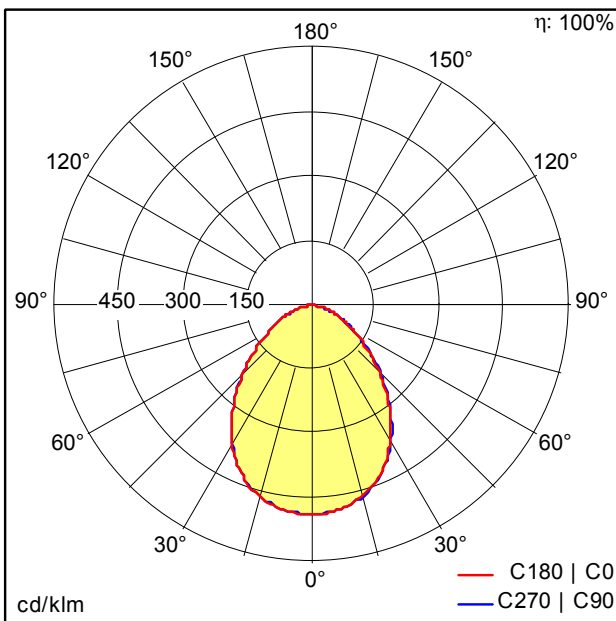

TE_ANNA_VF2_Q596_4400_840_FLEX1.idt

- Light Source: LED
- Luminaire luminous flux*: 4404 lm
- Total emergency luminous flux: 490 lm
- Luminaire efficacy*: 122 lm/W
- Colour Rendering Index min.: 80
- Correlated colour temperature*: 3000-4000 Kelvin
- Chromaticity tolerance (initial MacAdam): 4
- Rated median useful life*: L80 50000h at 25°C
- Ballast: 1x LED_Con
- Luminaire input power*: 36 W Power factor = 0.9
- Dimming: Fixed output
- Maintenance category CIE 97: D - Enclosed IP2X
- Total harmonic distortion (THD): 20.00 %

This product contains a light source of energy efficiency class D.

All values marked with an * are rated values. Connected electrical load and luminous flux are subject to an initial tolerance of +/- 10%, the most similar colour temperature is subject to an initial tolerance of +/- 150K. Unless stated otherwise, the values apply to an ambient temperature of 25°C.